

ø60

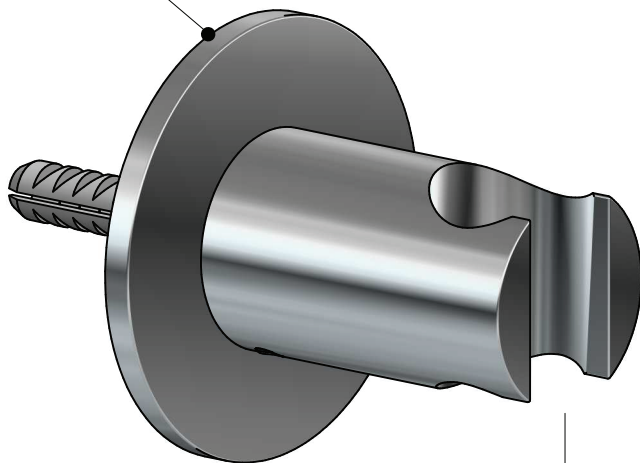

4

68